

Installation / User Manual

Photovoltaic Grid-connected
Microinverter(External WiFi-G3)

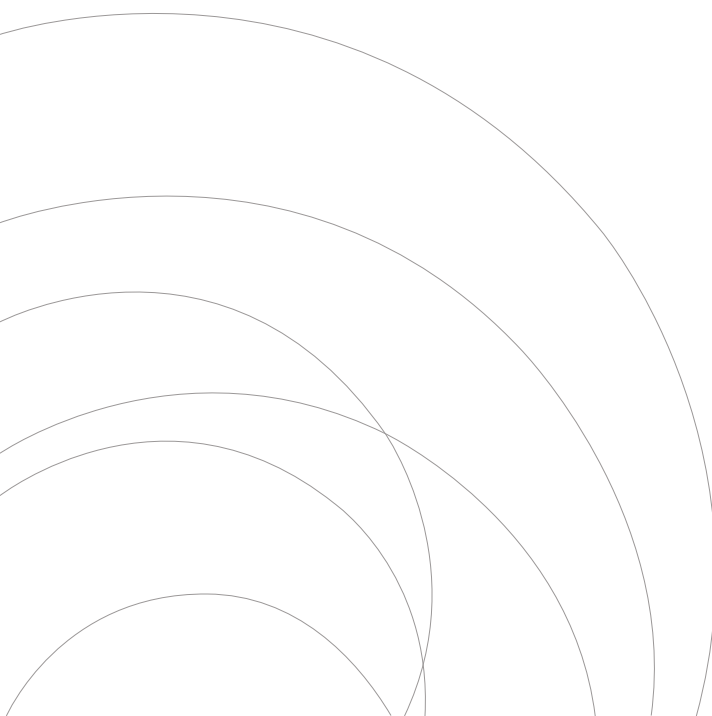

Ver:1.2, 2020-09
502011648

Table of Contents

Important Safety Instructions	01-03
Safety Instructions	
Radio Interference Statement	
The Meaning of Symbols	
Microinverter System Introduction	03-05
Microinverters Maximize PV Energy Production	
More Reliable than Centralized or String Inverters	
Simple to Install	
Microinverter Introduction	05
Microinverter System Installation	06-09
Additional Installation Components	
Required Parts and Tools from You	
Installation Procedures	
Microinverter System Operating Instructions	09-10
Troubleshooting	10-12
Status Indications and Error Reporting	
Troubleshooting a Non-operating Microinverter	
Replacement	13
Technical Data	14-16
300/500/600/800/1000G3 Microinverter Datasheet	
1300/1600/2000G3 Microinverter Datasheet	
Wiring Diagram	17-20
Monitoring Platform	21

Important Safety Instructions

This manual contains important instructions to follow during installation and maintenance of the Photovoltaic Grid-connected Inverter(Microinverter). To reduce the risk of electrical shock and ensure the safe installation and operation of the Microinverter, the following symbols appear throughout this document to indicate dangerous conditions and important safety instructions.

Specifications subject to change without notice - please ensure you are using the latest manual found at the manufacturer website.

WARNING: This indicates a situation where failure to follow instructions may cause a serious hardware failure or personnel danger if not applied appropriately. Use extreme caution when performing this task.

NOTE: This indicates information that is important for optimized microinverter operation. Follow these instructions strictly.

Safety Instructions

- ✓ **DO NOT** disconnect the PV module from the Microinverter without disconnecting the AC power.
- ✓ Only qualified professionals should install and/or replace the Microinverters.
- ✓ Perform all electrical installations in accordance with local electrical codes.
- ✓ Before installing or using the Microinverter, please read all instructions and cautionary markings in the technical documents and on the Microinverter system and the solar-array.
- ✓ Be aware that the body of the Microinverter is the heat sink and can reach a temperature of 80 °C . To reduce risk of burns,do not touch the body of the Microinverter.
- ✓ **DO NOT** attempt to repair the Microinverter. If it fails, contact technical support to obtain an RMA number and start the replacement process. Damaging or opening the Microinverter will void the warranty.
- ✓ Caution!
The external protective earthing conductor is connected to the inverter protective earthing terminal through AC connector.
When connecting, connect the AC connector first to ensure the inverter earthing then do the DC connections.
When disconnecting, disconnect the AC by opening the branch circuit breaker first

but maintain the protective earthing conductor in the branch circuit breaker connect to the inverter ,then disconnect the DC inputs.

- ✓ In any circumstance, do not connect DC input when AC connector is unplugged.
- ✓ Please install isolation switching devices on the AC side of the inverter.





Radio Interference Statement

CE EMC Compliance: The equipment can comply with CE EMC, which are designed to protect against harmful interference in a residential installation. The equipment could radiate radio frequency energy and this might cause harmful interference to radio communications if not following the instructions when installing and using the equipment. But there is no guarantee that interference will not occur in a particular installation. If this equipment causes harmful interference to radio or television reception, the following measures might resolve the issues:

- A) Relocate the receiving antenna and keep it well away from the equipment.
- B) Consult the dealer or an experienced radio / TV technical for help.

Changes or modifications not expressly approved by the party responsible for compliance may void the user's authority to operate the equipment.

The Meaning of Symbols

Can be OEM	Trademark.
	Caution, risk of electric shock.
	Caution, risk of burn - Do not touch.
	Caution, hot surface.
	Symbol for the marking of electrical and electronics devices according to Directive 2002/96/EC. Indicates that the device, accessories and the packaging must not be disposed as unsorted municipal waste and must be collected separately at the end of the usage. Please follow Local Ordinances or Regulations for disposal or contact an authorized representative of the manufacturer for information concerning the decommissioning of equipment.



CE mark is attached to the solar inverter to verify that the unit follows the provisions of the European Low Voltage and EMC Directives.



Refer to the operating instructions.

Qualified personnel

Person adequately advised or supervised by an electrically skilled person to enable him or her to perceive risks and to avoid hazards which electricity can create. For the purpose of the safety information of this manual, a "qualified person" is someone who is familiar with requirements for safety, refrigeration system and EMC and is authorized to energize, ground, and tag equipment, systems, and circuits in accordance with established safety procedures. The inverter and endues system may only be commissioned and operated by qualified personnel.

Microinverter System Introduction

The Microinverter is used in utility-interactive grid-tied applications, comprised of three key elements: Microinverter, MECD, Router.

There' re two kinds of communication method, PLC and Zigbee, for this series microinverter.

This series microinverter needs to connect MECD for remotely monitoring.

More information about MECD please refer to "MECD User Manual"

300 / 500 / 600 / 800 / 1000G3

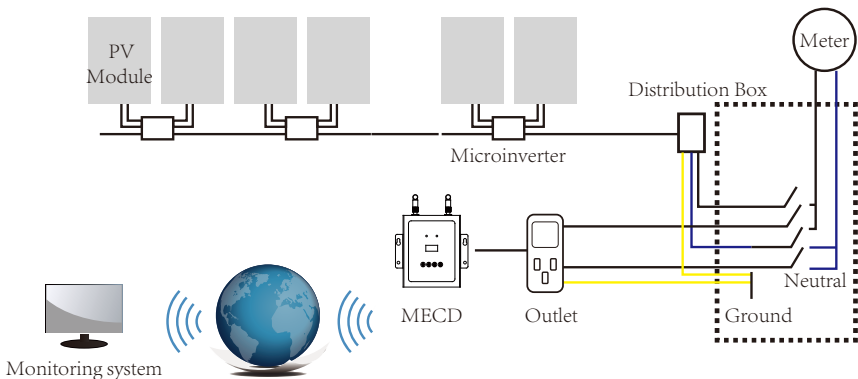

1300 / 1600 / 1800 / 2000G3

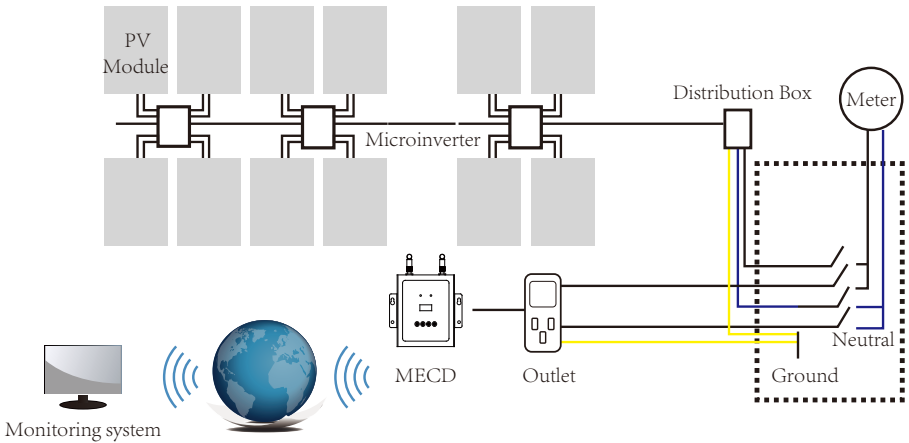

NOTE: If the wifi signal in the area where the MECD is weak, it is necessary to add a wifi signal booster at a suitable place between the router and the MECD.

This integrated system improves safety; maximizes solar energy harvest; increases system reliability, and simplifies solar system design, installation, maintenance, and management.

Microinverters Maximize PV Energy Production

Each PV module has individual Maximum Peak Power Tracking (MPPT) controls, which ensures that the maximum power is exported to the utility grid regardless of the performance of the other PV modules in the array. When PV modules in the array are affected by shade, dust, orientation, or any situation in which one module underperforms compared with the other units, the Microinverter ensures top performance from the array by maximizing the performance of each module within the array.

More Reliable than Centralized or String Inverters

The distributed Microinverter system ensures that no single point of system failure exists across the PV system. Microinverters are designed to operate at full power at ambient outdoor temperatures of up to 149°F (65°C). The inverter housing is designed for outdoor installation and complies with the IP65 environmental enclosure rating.

Simple to Install

You can install individual PV modules in any combination of Module quantity, orientation, different type and power rate The Ground wire (PE) of the AC cable is connected to the chassis inside of the Microinverter, potentially eliminating the installation of grounding wire (check local regulation).

Data collection adopts internal wifi, wireless router is needed near the microinverter. When complete the installation of microinverter, configure wireless router with internal wifi (refer to the wifi user manual). The data will be uploaded automatically. Users can monitor and manage the microinverter through corresponding website or APP.

Microinverter Introduction

The Microinverters connect with the single-phase grid, and can also use multiple Microinverters in the form of single-phase grid to achieve three-phase grid. For more information, please see the Technical Data page (P17~20) of this manual.

Model Number	AC grid	Max. # Per branch
SUN300G3-EU-230	50/60Hz, 230V	17 for 25A breaker
SUN500G3-EU-230	50/60Hz, 230V	10 for 25A breaker
SUN600G3-EU-230	50/60Hz, 230V	8 for 25A breaker
SUN800G3-EU-230	50/60Hz, 230V	6 for 25A breaker
SUN1000G3-EU-230	50/60Hz, 230V	5 for 25A breaker
SUN1300G3-EU-230	50/60Hz, 230V	4 for 25A breaker
SUN1600G3-EU-230	50/60Hz, 230V	4 for 45A breaker
SUN1800G3-EU-230	50/60Hz, 230V	3 for 45A breaker
SUN2000G3-EU-230	50/60Hz, 230V	3 for 45A breaker

Microinverter System Installation

A PV system using Microinverters is simple to install. Each Microinverter easily mounts on the PV racking, directly beneath the PV module(s). Low voltage DC wires connect from the PV module directly to the Microinverter, eliminating the risk of high DC voltage. Installation MUST comply with local regulations and technical rules.

Special Statement! An AC GFCI device should not be used to protect the dedicated circuit to the microinverter even though it is an outside circuit. None of the small GFCI devices (5~30mA) are designed for back feeding and will be damaged if back feed. In a similar manner, AC AFCIs have not been evaluated for back feeding and may be damaged if back feed with the output of a PV inverter.

WARNING: Perform all electrical installations in accordance with local electrical codes.

WARNING: Be aware that only qualified professionals should install and/or replace Microinverters.

WARNING: Before installing or using an Microinverter, please read all instructions and warnings in the technical documents and on the Microinverter system itself as well as on the PV array.

WARNING: Be aware that installation of this equipment includes the risk of electric shock.

WARNING: Do not touch any live parts in the system, including the PV array, when the system has been connected to the electrical grid.

NOTE: Strongly recommend to install Surge protection Devices in the dedicated meter box.

Additional Installation components

- AC Male and Female Interconnection Connectors (sold separately)
- Sealing end caps(sold separately)

Required Parts and Tools from you

In addition to your PV array and its associated hardware, you will need the following items:

- An AC connection junction box
- Mounting hardware suitable for module racking
- Sockets and wrenches for mounting hardware
- Continuous grounding conductor and grounding washers
- A Phillips screwdriver
- A torque wrench

Installation Procedures

Step 1 - Install the AC branch circuit junction box

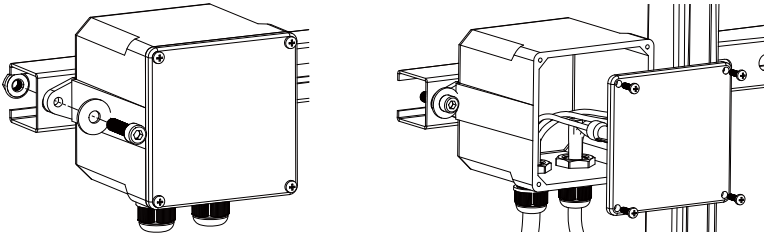

- a. Install an appropriate junction box at a suitable location on the PV racking system (typically at the end of a branch of modules).
- b. Connect the open wire end of the AC cable into the junction box using an appropriate gland or strain relief fitting.
- c. Wire the conductors of the AC(230/400Vac): L - red; N - black ;PE - yellow green.
- d. Connect the AC branch circuit junction box to the point of utility Interconnection.

WARNING: Wiring colour code can be different according local regulation,check all the wires of the installation before connecting to the AC cable to be sure they match. Wrong cabling can damage irreparably the microinverters,such an issue is not covered by the warranty.

Step 2 - Attach the Microinverters to the racking or the PV module frame

- a. Mark the location of the Microinverter on the rack, with respect to the PV module junction box or any other obstructions.
- b. Mount one Microinverter at each of these locations using hardware recommended by your module racking vendor.

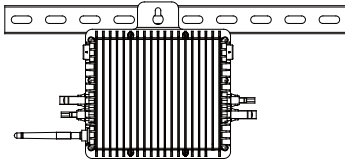

300 / 500G3 (1MPPT)
600 / 800 / 1000G3 (2MPPT)
Mounting

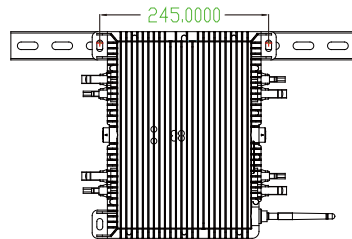

1300 / 1600 / 2000G3 (4MPPT)
Mounting

WARNING: Prior to installing any of the microinverters, verify that the utility voltage at the point of common connection matches the voltage rating on microinverter label.

WARNING: Do not place the inverters (including DC and AC connectors) where exposed to the sun, rain or snow, even gap between modules. Allow a minimum of 3/4 (1.5cm.) between the roof and the bottom of the Microinverter to allow proper air flow.

Step 3 - Connect the microinverters in parallel



300/500G (1MPPT)
600/800/1000G3 (2MPPT)
connect in parallel



1300/1600/2000G3 (4MPPT)
connect in parallel

- a. Check the Microinverter technical data page 5 for the maximum allowable number of Microinverters on each AC branch circuit.
- b. Plug the male AC connector of the Microinverter into the female connector to get it connected. AC connector interface as follows.

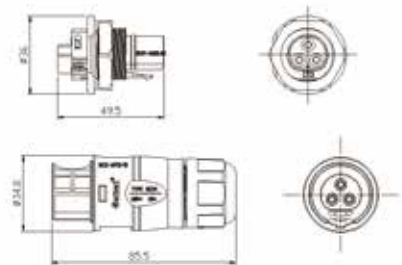
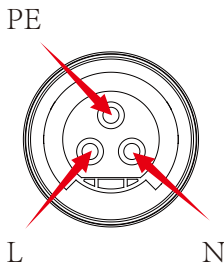

WARNING: DO NOT exceed maximum number of Microinverters in an AC branch circuit, as displayed on the page 5 of this manual.

Step 4 - Install an AC cable protective end cap at the end of AC cable



Step 5 - Connect Microinverter to the PV Modules

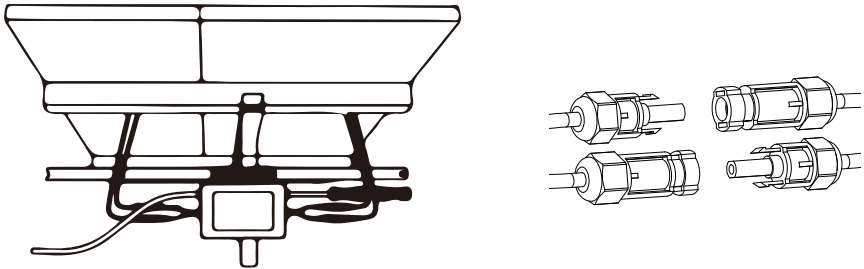

NOTE: When plugging in the DC cables, if AC already available, the Microinverter should immediately blink red light and will start work within the setting time (default 60 seconds). If AC is not available, the red light will blink 3 times quickly and repeat after one second until AC is connected.

Microinverter System Operating Instructions

To operate the microinverter PV system:

1. Turn ON the AC circuit breaker on each microinverter AC branch circuit.
2. Turn ON the main utility-grid AC circuit breaker. Your system will start producing power after a one-minute waiting time.

-
-
3. The units should start blinking red one minutes after turning on the AC circuit breaker. Then blue led blinking. This means they are producing power normally, the faster blinking of the blue led means more power generated.
 4. Configure the internal wifi module according to its user manual.
 5. The Microinverters will start to send performance data over wifi module to the network every 5 minutes.It enables customers to monitor performance data of each microinverter through website and APP.

NOTE: When AC power is applied but the microinverter not started up, about 0.1A current and 25VA(W) power for each microinverter may be measured by a power meter. This power is reactive power,not consume from utility grid.

Troubleshooting

Qualified personnel can use the following troubleshooting steps if the PV system does not operate correctly:

Status Indications and Error Reporting

Start up LED

One minute after DC power is first applied to the microinverter,one short red blinks indicate a successful microinverter startup sequence, be equal or greater than two short red blinks after DC power is first applied to the microinverter indicate a failure during microinverter setup.

Operation LED

Flashing Slow Blue	- Producing small power
Flashing Fast Blue	- Producing big power
Flashing Red	- Not producing power
Red blinking two times	- AC low-voltage or high-voltage
Red blinking three times	- Grid failure

GFDI Error

A four time red LED indicates the Microinverter has detected a Ground Fault Detector Interrupter (GFDI) error in the PV system. Unless the GFDI error has been cleared, the LED will remain four times blinking.

Other Faults

All other faults can be reported to the website and APP.

WARNING: Never disconnect the DC wire connectors under load. Ensure that no current is flowing in the DC wires prior to disconnecting. An opaque covering may be used to cover the module prior to disconnecting the module.

Troubleshooting a non-operating Microinverter

There are two possible overall areas of trouble:

- A. The Microinverter itself may be having problems.
- B. The Microinverter itself is working fine but the communication between microinverter and network has problem. The items below refer to Microinverter issues, not communication issues:

One quick way to tell whether the issue is the Microinverter or the communication problem:

1. Diagnosing from the Microinverter: A red light – either blinking or solid on the Microinverter, or no light at all means it is definitely the Microinverter problem.
2. 0 watts, or 2 watts: Possibly a Microinverter problem

2. Diagnosing from the network:

- a. No-Data-Display: The website and APP don't display any data. Check the network configuration.
- b. Only display microinverter is online but no data. This maybe because server is updating.

To troubleshoot a non-operating Microinverter, Follow the steps below in order:

1. Verify the utility voltage and frequency are within ranges shown in the Technical Data section of this manual.
2. Check the connection to the utility grid. Disconnect AC firstly, then disconnect DC and make sure the utility grid voltage can be measured at AC connector. Never disconnect the DC wires while the microinverter is producing power. Re-connect the DC module connectors and watch for three short LED flashes.
3. Check the AC branch circuit interconnection between all the microinverters. Verify each inverter is energized by the utility grid as described in the previous step.
4. Make sure that any AC breaker are functioning properly and are closed.
5. Check the DC connections between the microinverter and the PV module.
6. Verify the PV module DC voltage is within the allowable range shown in the Technical Data of this manual.
7. If the problem still persists, please contact technical support.

WARNING: Do not attempt to repair the microinverter. If troubleshooting methods fail, please call for Technical Support

Replacement

Follow the procedure to replace a failed Microinverter

- A. Disconnect the Microinverter from the PV Module, in the order shown below:
1. Disconnect the AC by turning off the branch circuit breaker.
 2. Disconnect the AC connector of the microinverter.
 3. Cover the module with an opaque cover.
 4. Disconnect the PV module DC wire connectors from the Microinverter.
 5. Remove the Microinverter from the PV array racking.
- B. Remove the opaque cover, Install a replaced Microinverter to the bracket.
Remember to observe the flashing LED light as soon as the new Microinverter is plugged into the DC cables.
- C. Connect the AC cable of the replacement Microinverter.

Technical Data

WARNING: Be sure to verify the voltage and current specifications of your PV module match with those of the Microinverter. Please refer to the datasheet or user manual.

WARNING: You must match the DC operating voltage range of the PV module with the allowable input voltage range of the Microinverter.

WARNING: The maximum open circuit voltage of the PV module must not exceed the specified maximum input voltage of the inverter.

300G3/500G3/600G3 Microinverter Datasheet

Model	SUN300G3 -EU-230	SUN500G3 -EU-230	SUN600G3 -EU-230
Input Data (DC)			
Recommended input power(STC)	210~400W	210~600W	210~400W
Maximum input DC voltage	60V		
MPPT Voltage Range	25~55V		
Operating DC Voltage Range	20~60V		
Max DC short circuit current	16A	16A	16A
Max input current	10.5A × 1	12.5A × 1	10.5A × 2
Output Data (AC)			
Rated output Power	300W	500W	600W
Maximum output power	330W	550W	660W
Maximum output Current	1.4A	2.4A	2.9A
Nominal voltage / range	230V / 184-265V		
Nominal frequency	50/60Hz		
Extended frequency / range	45~55Hz/ 55~65Hz		
Power factor	>0.99		
Maximum unit per branch	17	10	8
Max. allowed altitude operating	< 4000m		
Max.inverter backfeed current to the array	0A		
Max output fault current	10A		
Max output overcurrent protection	1.4A	2.4A	2.9A
Efficiency			
CEC weighted efficiency	95%		
Peak inverter efficiency	96.5%		
Static MPPT efficiency	99%		
Night time power consumption	50mW		
Mechanical Data			
Ambient temperature range	-40 °C ~ +65 °C		
Dimensions(W × H × D mm)	212 × 229 × 40 mm (Does not include cable)		
Weight (kg)	3.5		
Cooling	Natural Convection - No Fans		
Enclosure environmental rating	IP67		
Protective class	Class I		
Features			
Compatibility	Compatible with 60,72 cell PV modules		
Communication	Power line / WiFi / Zigbee		
Compliance	EN50549,VDE0126,VDE4105,IEC62109,CE,INMETRO		
Warranty	10 Years		

800G3/1000G3 Microinverter Datasheet

Model	SUN800G3 -EU-230	SUN1000G3 -EU-230
Input Data (DC)		
Recommended input power(STC)	210~600W	
Maximum input DC voltage	60V	
MPPT Voltage Range	25~55V	
Operating DC Voltage Range	20~60V	
Max DC short circuit current	16A	
Max input current	12.5A×2	
Output Data (AC)		
Rated output Power	800W	1000W
Maximum output power	880W	1100W
Maximum output Current	3.8A	4.8A
Nominal voltage / range	230V / 184-265V	
Nominal frequency	50/60Hz	
Extended frequency / range	45~55Hz/ 55~65Hz	
Power factor	>0.99	
Maximum unit per branch	6	5
Max. allowed altitude operating	< 4000m	
Max.inverter backfeed current to the array	0A	
Max output fault current	10A	
Max output overcurrent protection	3.8A	4.8A
Efficiency		
CEC weighted efficiency	95%	
Peak inverter efficiency	96.5%	
Static MPPT efficiency	99%	
Night time power consumption	50mW	
Mechanical Data		
Ambient temperature range	-40 °C ~ +65 °C	
Dimensions(W×H×D mm)	212×229×40 mm (Does not include cable)	
Weight (kg)	3.5	
Cooling	Natural Convection - No Fans	
Enclosure environmental rating	IP67	
Protective class	Class I	
Features		
Compatibility	Compatible with 60,72 cell PV modules	
Communication	Power line / WiFi / Zigbee	
Compliance	EN50549,VDE0126,VDE4105,IEC62109,CE,INMETRO	
Warranty	10 Years	

1300G3/1600G3/1800G3/2000G3 Microinverter Datasheet

Model	SUN1300G3 -EU-230	SUN1600G3 -EU-230	SUN1800G3 -EU-230	SUN2000G3 -EU-230
Input Data (DC)				
Recommended input power(STC)	210~400W	210~600W	210~600W	210~600W
Maximum input DC voltage	60V			
MPPT Voltage Range	25~55V			
Operating DC Voltage Range	20~60V			
Max DC short circuit current	16A			
Max input current	10.5A×4	12.5A×4	12.5A×4	12.5A×4
Output Data (AC)				
Rated output Power	1300W	1600W	1800W	2000W
Maximum output power	1430W	1760W	1980W	2200W
Maximum output Current	6.2A	7.7A	8.6A	9.6A
Nominal voltage / range	230V / 184-265V			
Nominal frequency	50/60Hz			
Extended frequency / range	45~55Hz/ 55~65Hz			
Power factor	>0.99			
Maximum unit per branch	4	4	3	3
Max. allowed altitude operating	< 4000m			
Max.inverter backfeed current to the array	0A			
Max output fault current	10A			
Max output overcurrent protection	6.2A	7.7A	8.6A	9.6A
Efficiency				
CEC weighted efficiency	95%			
Peak inverter efficiency	96.5%			
Static MPPT efficiency	99%			
Night time power consumption	50mW			
Mechanical Data				
Ambient temperature range	-40 C ~ +65 C			
Dimensions(W×H×D mm)	267×300×42.5 mm (Does not include cable)			
Weight (kg)	5.2			
Cooling	Natural Convection - No Fans			
Enclosure environmental rating	IP67			
Protective class	Class I			
Features				
Compatibility	Compatible with 60,72 cell PV modules			
Communication	Power line / WiFi / Zigbee			
Compliance	EN50549,VDE0126,VDE4105,IEC62109,CE,INMETRO			
Warranty	10 Years			

Wiring Diagram

Sample Wiring Diagram Three Phase

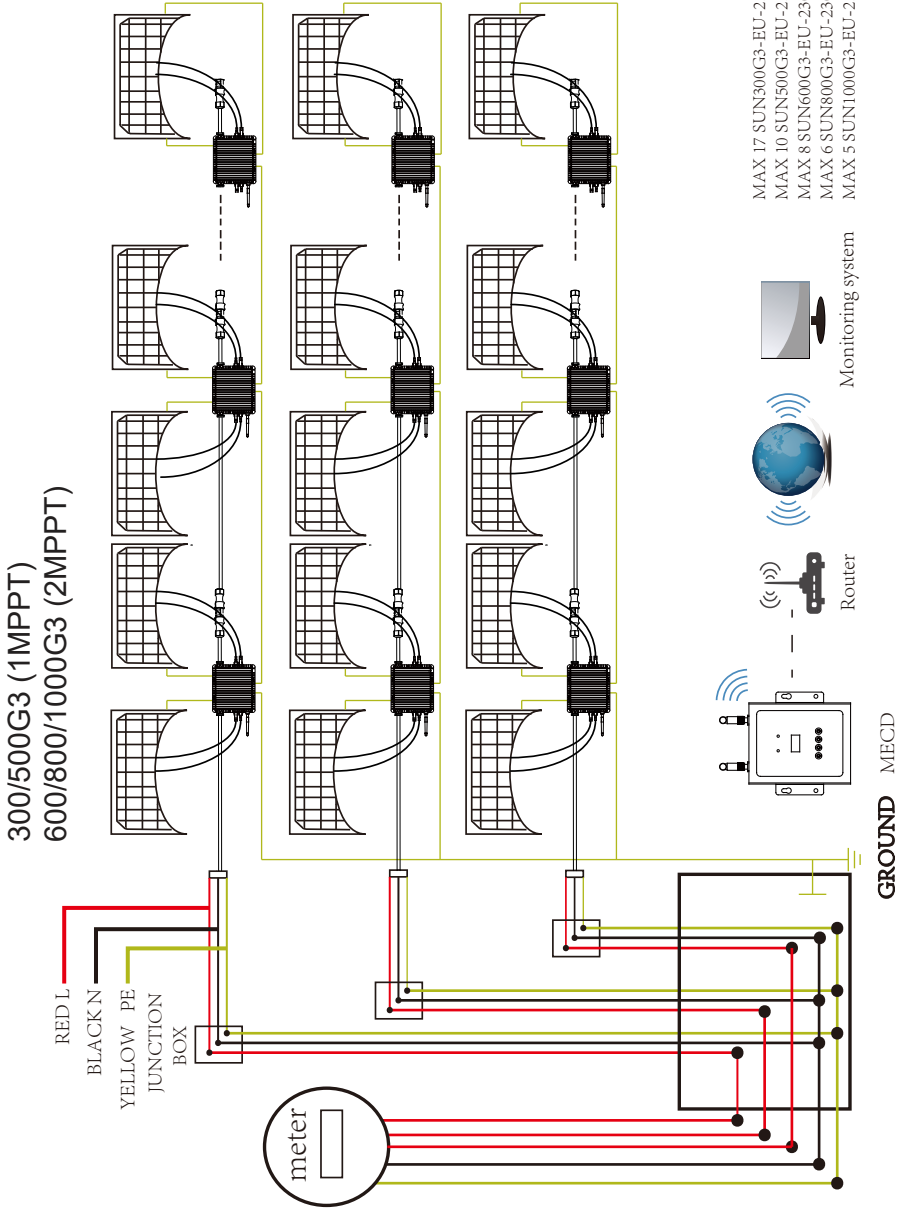

Sample Wiring Diagram Single Phase

300/500G3 (1MPPT)
600/800/1000G3 (2MPPT)

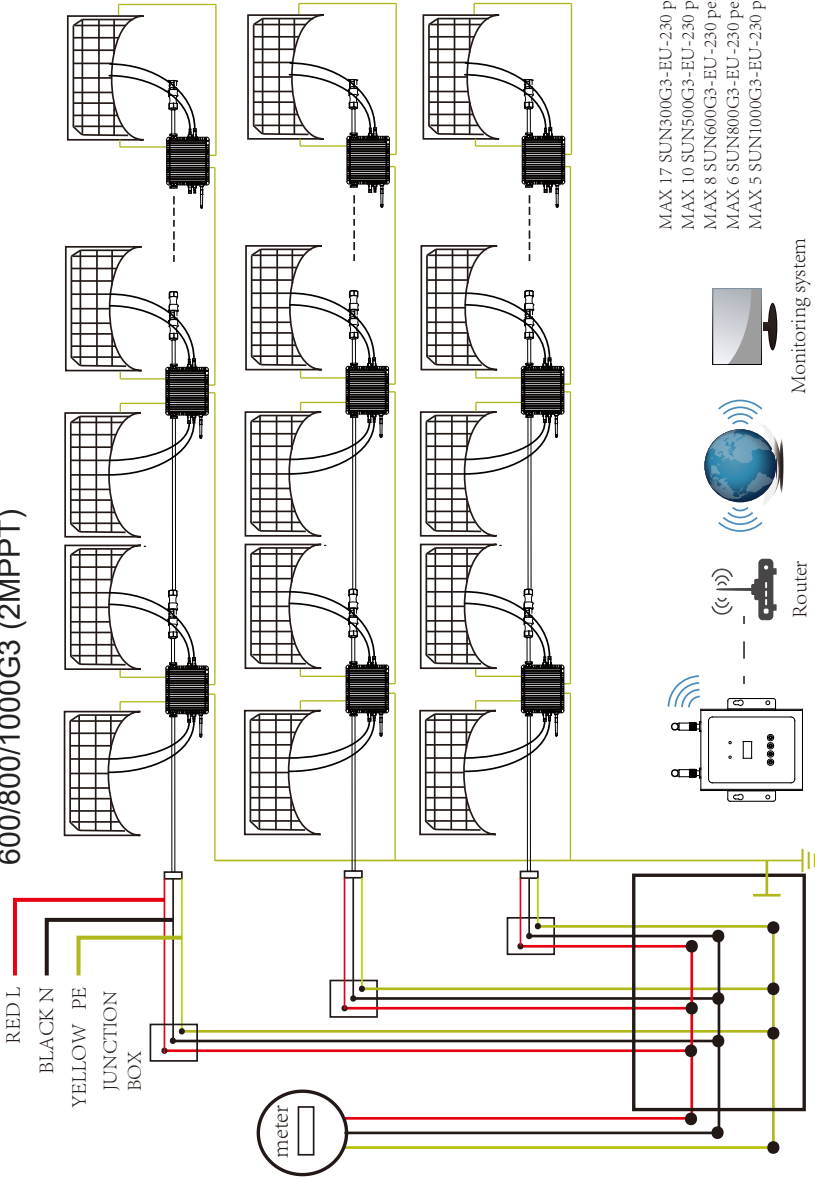

MAX 17 SUN300G3-EU-230 per Branch
MAX 10 SUN500G3-EU-230 per Branch
MAX 8 SUN600G3-EU-230 per Branch
MAX 6 SUN800G3-EU-230 per Branch
MAX 5 SUN1000G3-EU-230 per Branch

Monitoring system

Router

GROUND MECD

Sample Wiring Diagram Three Phase

1300/1600/1800/2000G3 (4MPPT)

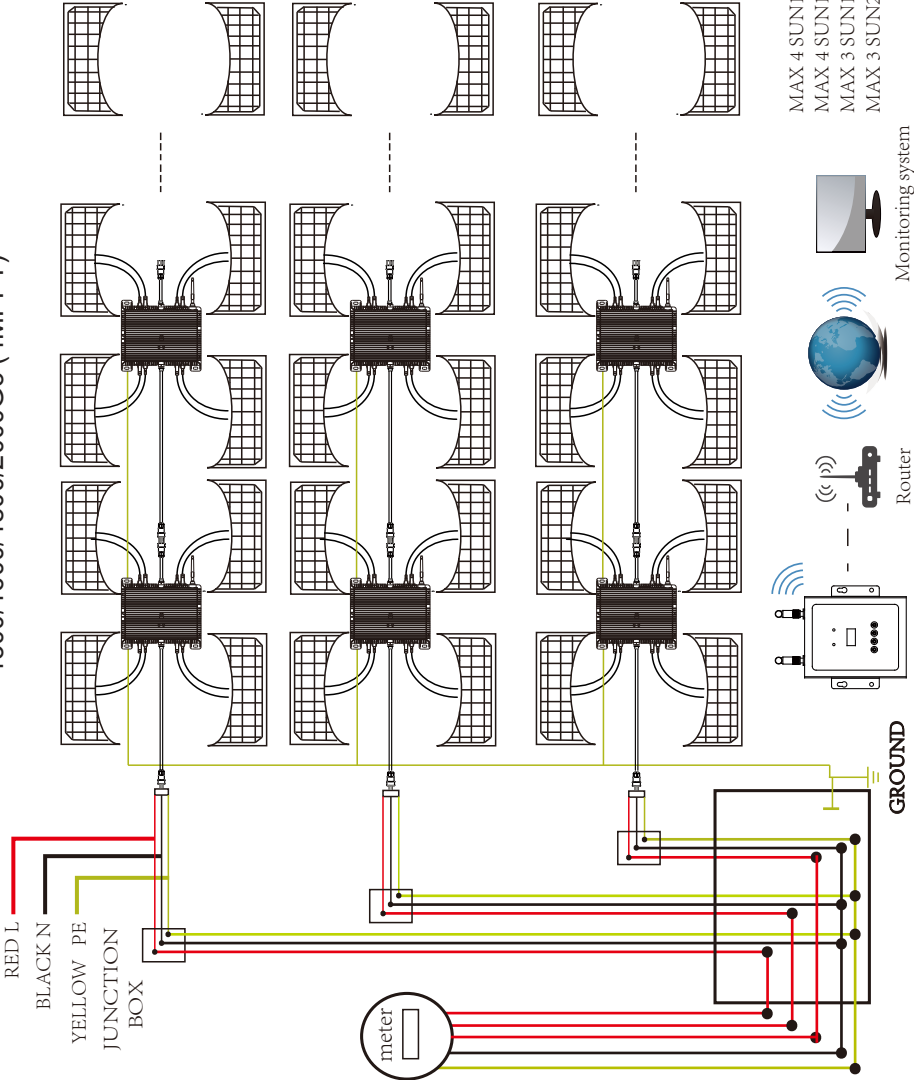

- MAX 4 SUN1300G3-EU-230 per Branch
- MAX 4 SUN1600G3-EU-230 per Branch
- MAX 3 SUN1800G3-EU-230 per Branch
- MAX 3 SUN2000G3-EU-230 per Branch

Monitoring system

Router

MECD

GROUND

Sample Wiring Diagram Single Phase

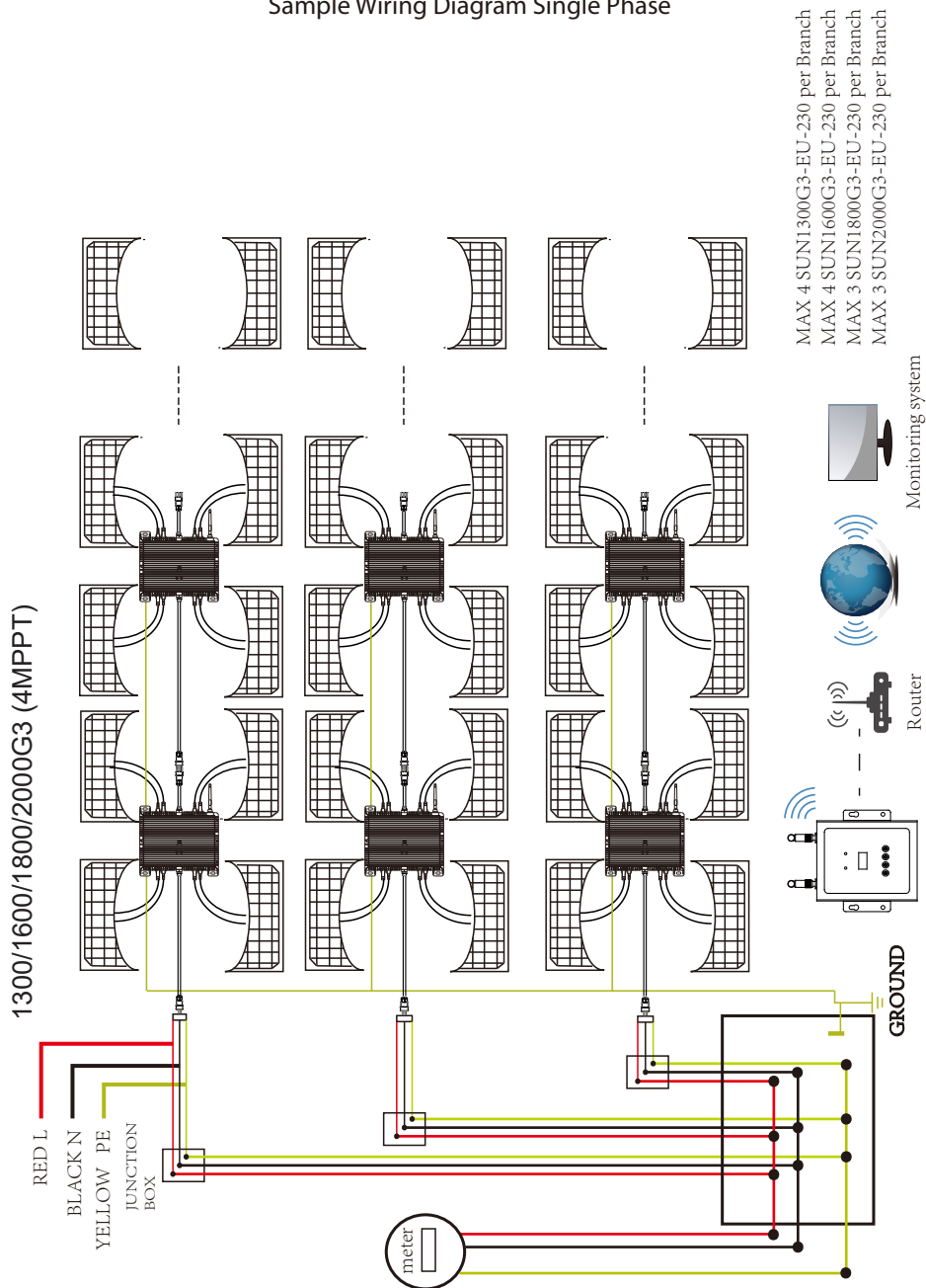

Monitoring Platform

This series microinverter needs to connect MECD for remotely monitoring. For WIFI configuration, please check of the MECD Manual.

Web monitoring address: <https://pro.solarmanpv.com>; (for Solarman distributor account)
<https://home.solarmanpv.com> (for Solarman end user account)

For mobile phone monitoring system, scan the QR code to download the APP. Also, you could find it by searching “solarman” in App store or Google Play.



IOS/Android system for
plant owner account



IOS/Android system for
distributor account

